

REV.	DATE	ECO	DESCRIPTION	BY	CK	APP
-	8/14/2013	N/A	INITIAL RELEASE	GDR	N/A	N/A

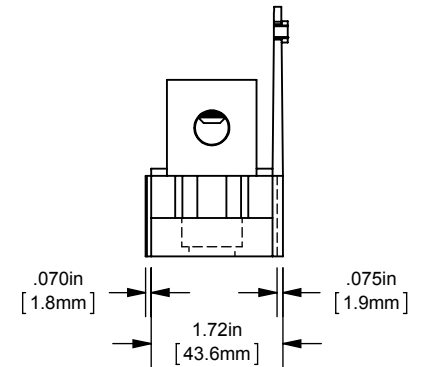

BACK VIEW  
ADDER  
(MPDB66560)  
SHOWN

DIMENSIONS IN [ ] ARE MILLIMETERS

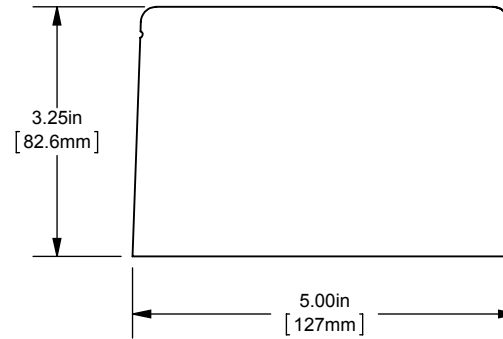
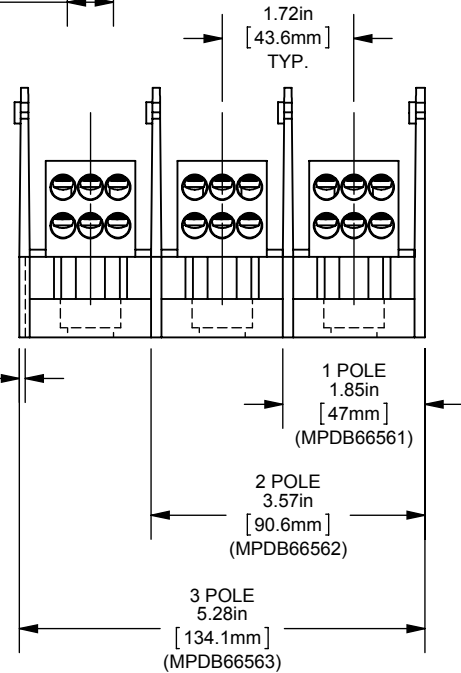
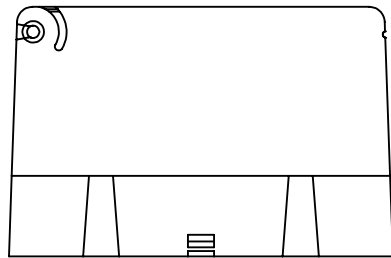
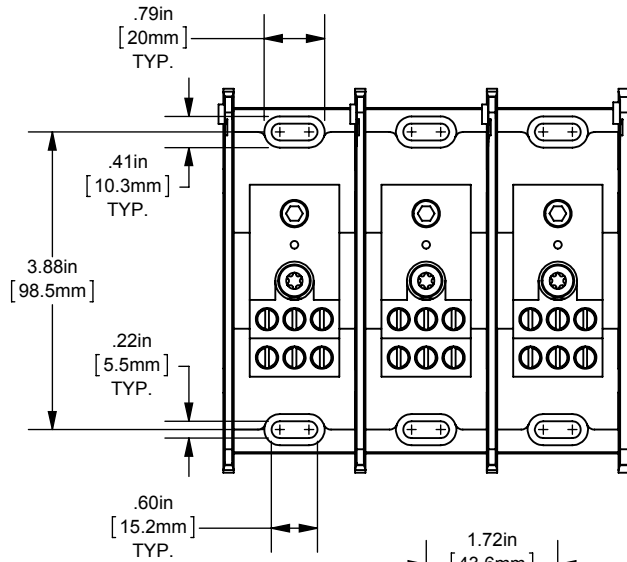

MERSEN USA NEWBURYPORT-MA, LLC  
374 MERRIMAC STREET  
NEWBURYPORT, MA 01950

MPDB(66560,66561,66562,66563)

PDB 1-3P, ADDER COPPER INTERMEDIATE

(1) 2/0-14 X (6) 2-14

OUTLINE DIMENSIONS  
NOT TO BE USED FOR PRODUCTION

701910

PRODUCT MANAGER

SIGN:

DATE:

DESIGN ENGINEER

SIGN:

DATE: (SEE ECO)