

REV	DATE	ECO	DESCRIPTION	BY	CK	APP
A	3-18-08	NA	UPDATED OUTLINE FORMAT AND DIMENSIONS	LDB	NA	NA

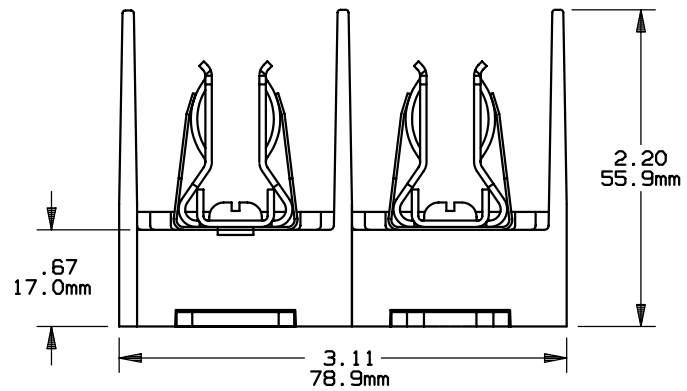
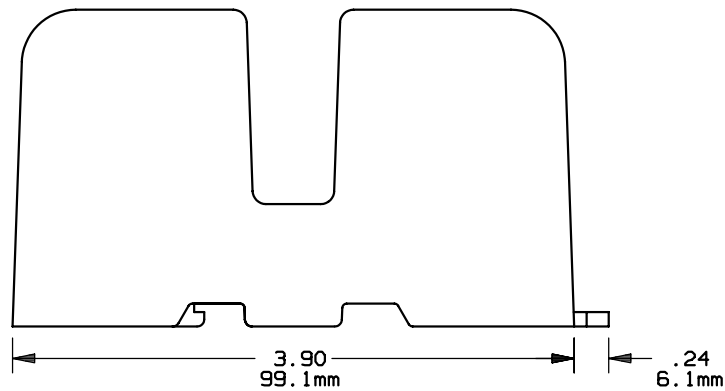
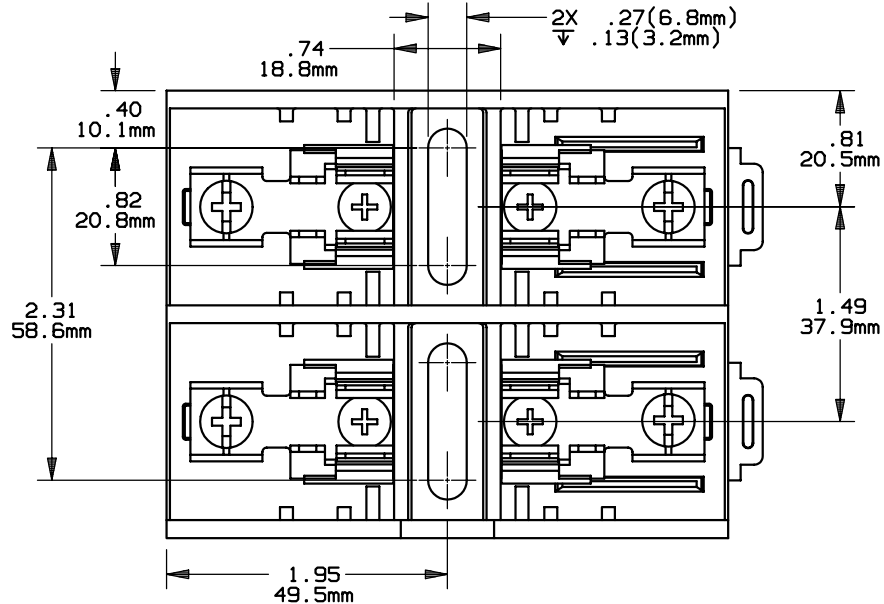

P/N	CONN TYPE	RMS SYM RATING	TORQUE (IN-LBS)	WIRE		U/L		CSA
				°C	TYPE	FILE NO.	GUIDE NO.	REPORT NO.
60617T	SCREW	200K	20	60/75	CU ONLY	E52283	IZLT2	LR32169

- NOTES:
1. TOLERANCES ±.015 UNLESS OTHERWISE SPECIFIED.
 2. MATERIAL COMPOSITION AND RATING THERMOPLASTIC-125°C RTI.

MERSEN
 MERSEN USA NEWBURYPORT-MA, LLC
 374 MERRIMAC STREET
 NEWBURYPORT, MA 01950

PRODUCT MANAGER	DESIGN ENGINEER
SIGN:	SIGN:
DATE:	DATE:

FUSE BLOCK, 600V-60A, 2 POLE CLASS T

OUTLINE DIMENSIONS NOT TO BE USED FOR PRODUCTION

700060