

REV.	DATE	ECO	DESCRIPTION	BY	CK	APP
-	8/26/2013	N/A	INITIAL RELEASE	GDR	N/A	N/A

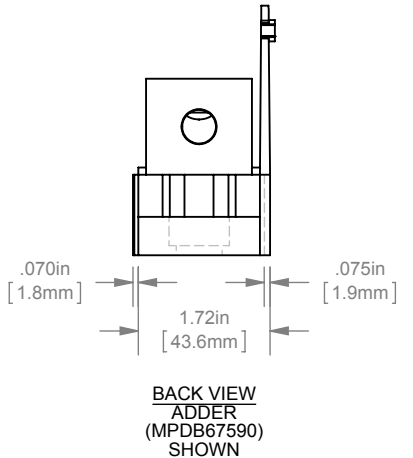

DIMENSIONS IN [] ARE MILLIMETERS

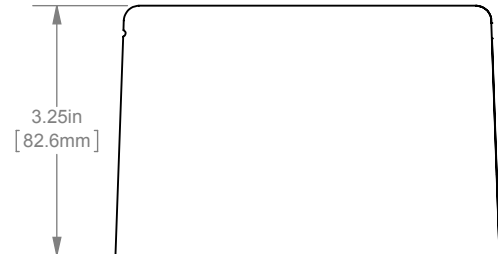
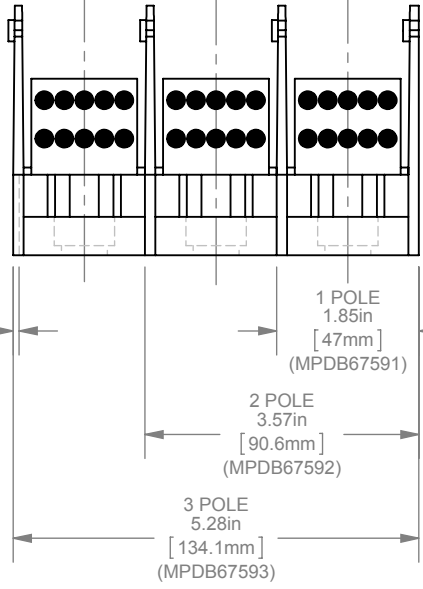
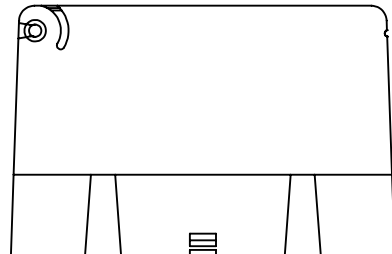
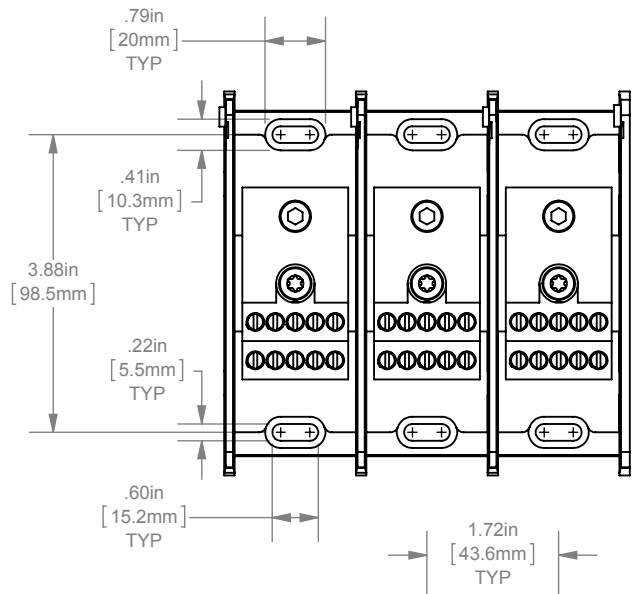

MERSEN USA NEWBURYPORT-MA, LLC
374 MERRIMAC STREET
NEWBURYPORT, MA 01950

MPDB(67590,67591,67592,67593)

PDB 1-3, ADDER ALUMINUM INTERMEDIATE

(1) 2/0-14 X (10) 6-14

OUTLINE DIMENSIONS
NOT TO BE USED FOR PRODUCTION

701964

PRODUCT MANAGER
SIGN:
DATE:

DESIGN ENGINEER
SIGN:
DATE: (SEE ECO)